

# ME-12-P series

[Square Wave/Incremental]

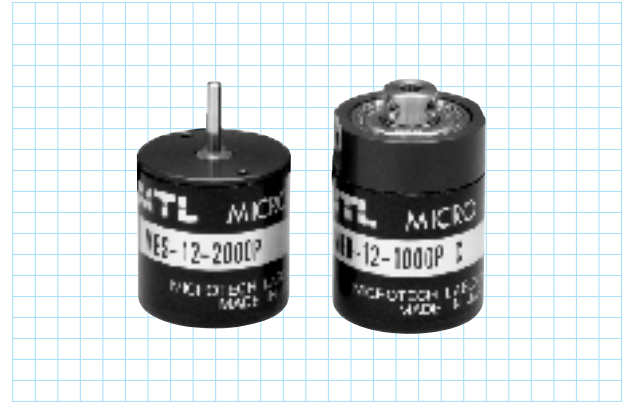

## Outside dimensions

MES-12

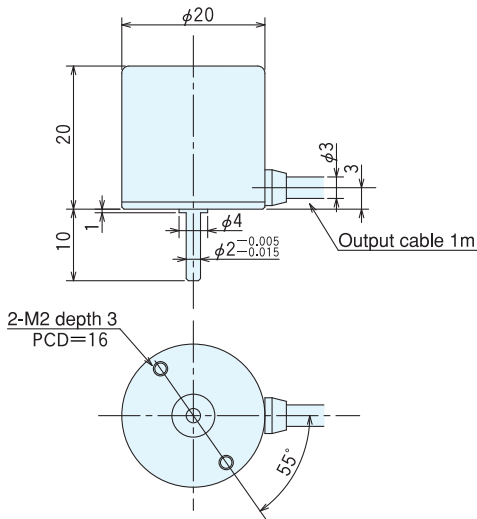

MEH-12

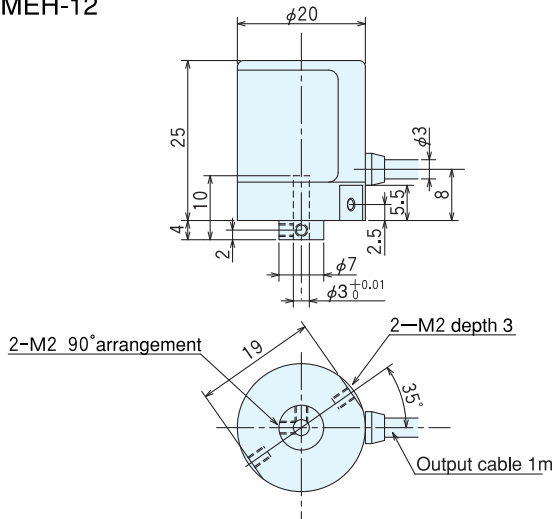

## Specifications

Type name		ME□-12-□P□	
Item		Shaft shape ●S=single shaft ●H=hollow shaft	Pulse number ●No entry=voltage output ●C=open collector output ●E=line driver output ●S=sine wave output ●ST=built-in multiplication circuit
Supply voltage		DC5V ±10%	
Current consumption		40mA or less (under no load)	
Detection system		Incremental	
Output pulse number (Standard)		100 200 256 300 360	500 600 900 1,000 1,024
[Pulse number/rotation]		1,500 1,800 2,000 2,048	
Output phase		A, B, Z phase	
Output form		Square wave	
Output capacity		Sink current: 20mA Residual voltage: 0.5V or less (at 10mA)	
Maximum response frequency (response pulse number)		100kHz	
Output phase difference		A, B phase difference 90°±45° (T/4±T/8) Z phase T±T/2 (see Output Waveform)	
Waveform rise/fall time		2μs or less (output cable 1m or less)	
Starting torque		1×10 <sup>-3</sup> N·m (10gf·cm) or less	
Allowable load of shaft (electrical)	Radial	1.9N (200gf)	0.98N (100gf)
	Thrust	1.9N (200gf)	0.98N (100gf)
Maximum allowable revolutions (mechanical)		6,000/rmin	
Working ambient temperature/humidity		-10°C~70°C RH35%~90% no dewing	
Storing ambient temperature		-20°C~80°C	
Vibration resistance		Durability 55Hz, double amplitude 1.5mm 2 hours each in X, Y, and Z directions	
Impact resistance		Durability 500m/s <sup>2</sup> (about 50G) 3 times each in X, Y, and Z directions	
Cable		Outside diameter φ3 5-core vinyl wire Insulated shield cable (length 1m)	
Mass		40g	

## Output circuit diagram

Voltage output (standard type)

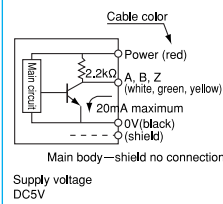

Open collector output (option)

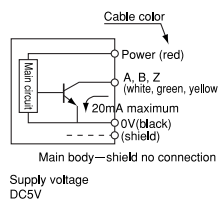

Line driver output (option)

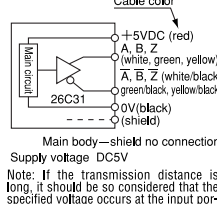

A capacitor (0.1 μF) is connected between 0V and FG (frame ground).

## Output waveform

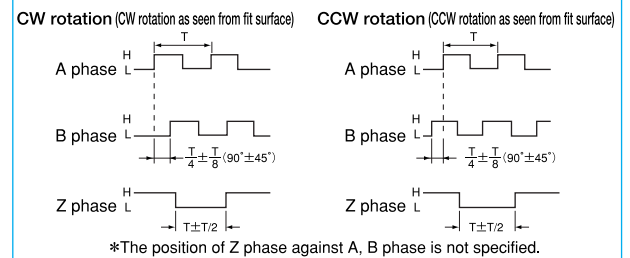

### Specifications/Sine wave

Supply voltage	DC5V ±10%	
Current consumption	40mA or less (under no load)	
Detection system	Sine wave·Incremental	
Output	Output pulse number (Standard) [Pulse number/rotation]	1,000 2,000 1,500 2,048 1,800
	Output phase	A, B, Z phase
	Output form	A, B phase SIN wave, Z phase square wave
	A, B, Z phase output	SIN wave 1.5 Vp-p±0.3 V offset 2.0V±0.2V
		Opamp output current 5mA Max.
		Harmonic distortion factor to be within 10% (Measuring condition to be within 20 kHz, effective value mean distortion factor measuring instrument)
	Maximum response frequency	50kHz
Output phase difference	A, B phase difference 90°±45° (T/4±T/8) Z phase T±T/2 (see Output Waveform)	
Waveform rise/fall time	2μs or less (output cable 1m or less)	
Starting torque	1×10 <sup>-3</sup> N·m or less	
Allowable load of shaft (electrical)	Radial	0.98N (100gf)
	Thrust	0.98N (100gf)
Maximum allowable revolutions (mechanical)	6,000r/min	
Working ambient temperature/humidity	0°C~50°C RH35%~90% no dewing	
Storing ambient temperature	-20°C~80°C	
Vibration resistance	Durability 55Hz, double amplitude 1.5mm 2 hours each in X, Y, and Z directions	
Impact resistance	Durability 500m/s <sup>2</sup> (about 50G) 3 times each in X, Y, and Z directions	
Cable	Outside diameter φ3 5-core vinyl wire Insulated shield cable (length 1m)	
Mass	40g	

### Output circuit diagram

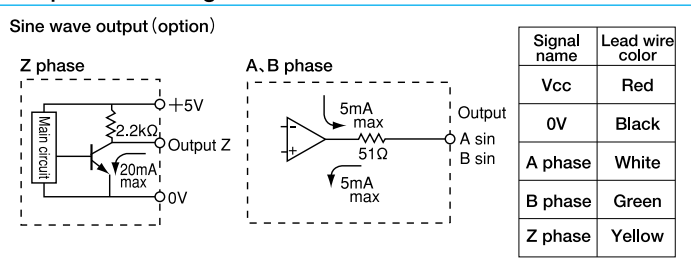

A capacitor (0.1μF) is connected between 0V and FG (frame ground).

### Output waveform

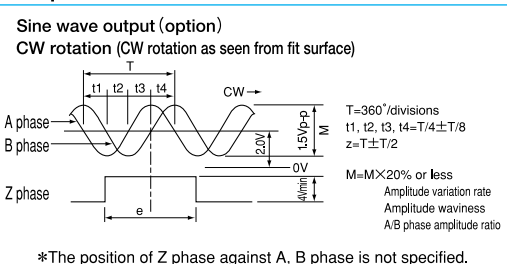

### Specifications Built-in multiplication circuit (×2·×4·×8·×16)

Supply voltage	DC5V ±5%	
Current consumption	60mA or less (under no load)	
Detection system	Incremental	
Output	Output pulse number (Standard) [Pulse number/rotation]	EX 2,000×2 (4,000) 2,000×4 (8,000) 2,000×8 (16,000) 2,000×16 (32,000)
	Output phase	A, B, Z phase
	Output form	Square wave
	Maximum response frequency	Line driver output:50kHz× (by multiplication) Voltage output·Open collector output:100kHz
	Output phase difference	See the diagram below.
Waveform rise/fall time	2μs or less (output cable 1m or less)	
Starting torque	1×10 <sup>-3</sup> N·m or less	
Allowable load of shaft (electrical)	Radial	0.98N (100gf)
	Thrust	0.98N (100gf)
Maximum allowable revolutions (mechanical)	6,000r/min	
Working ambient temperature/humidity	-10°C~70°C RH35%~90% no dewing	
Storing ambient temperature	-20°C~80°C	
Vibration resistance	Durability 55Hz, double amplitude 1.5mm 2 hours each in X, Y, and Z directions	
Impact resistance	Durability 500m/s <sup>2</sup> (about 50G) 3 times each in X, Y, and Z directions	
Cable	Outside diameter φ3 5-core vinyl wire Insulated shield cable (length 1m)	
Mass	40g	

### Output circuit diagram

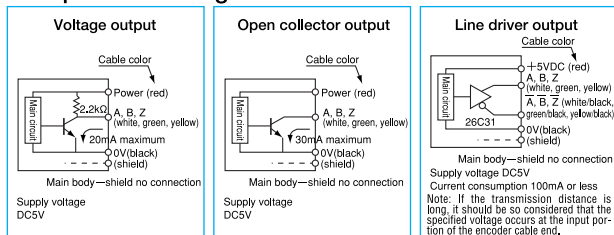

A capacitor (0.1μF) is connected between 0V and FG (frame ground).

### Output waveform

